

AL150.P0001

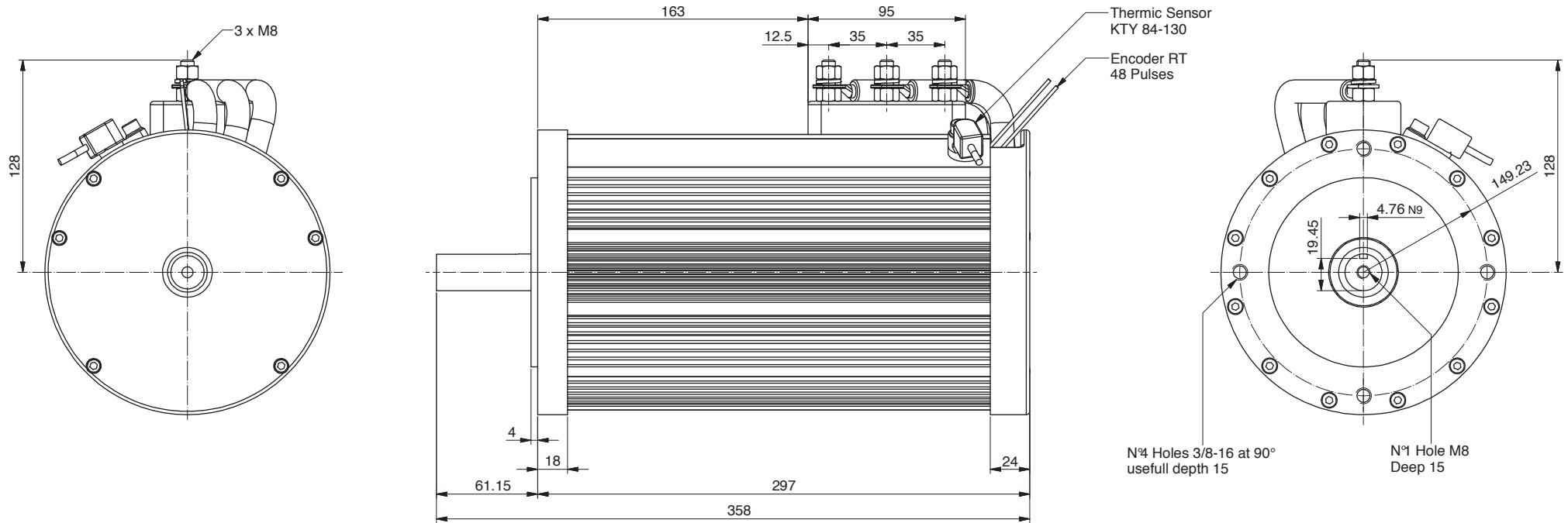

Power	2500 W
Tension	48 V
Speed	2500 Rpm
Torque	9.6 Nm
Enclosure	IP 20

