

AL173.P0001

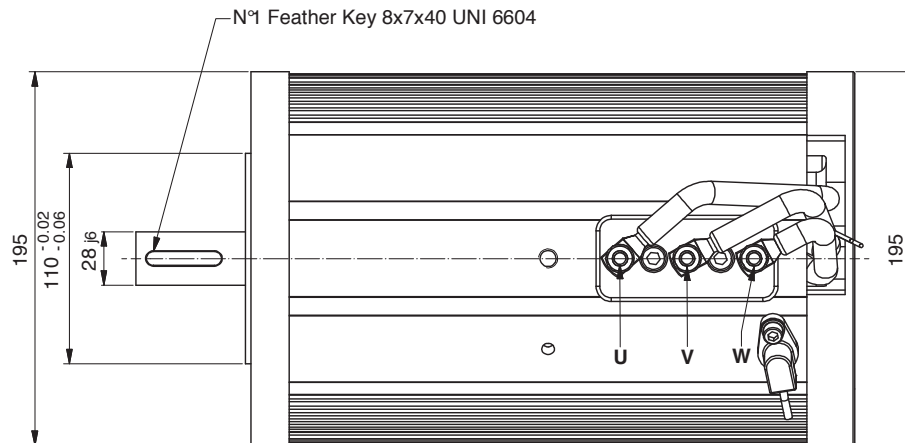
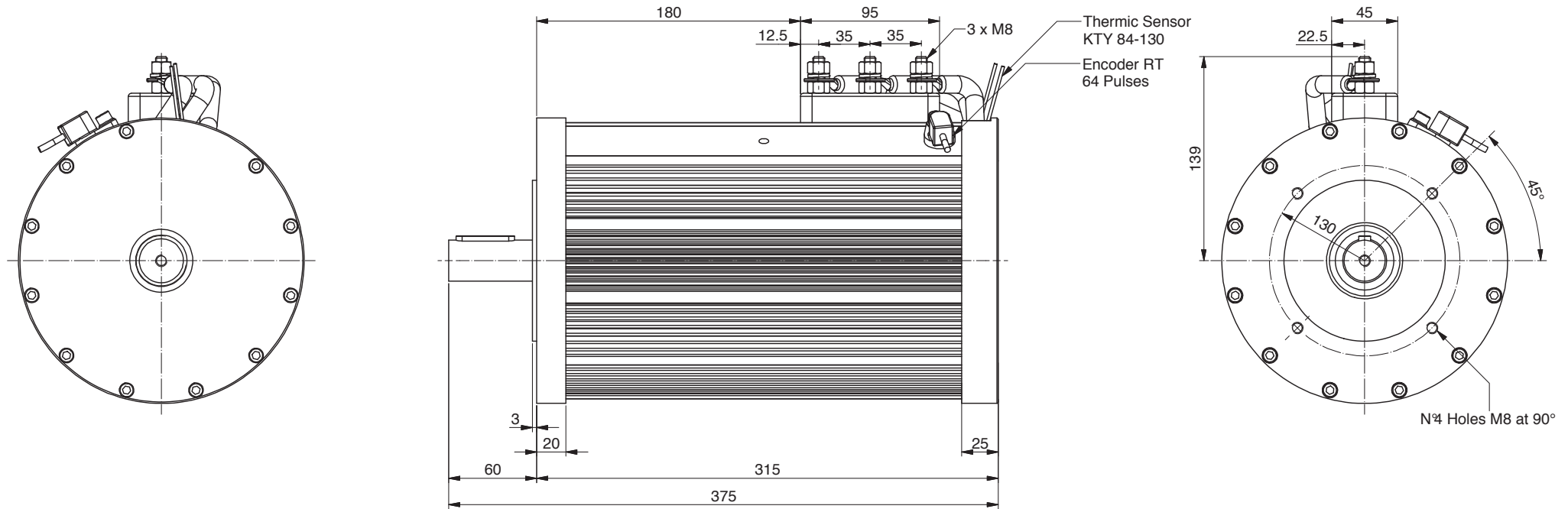

Power	4000 W
Tension	48 V
Speed	2500 Rpm
Torque	15.2 Nm
Enclosure	IP 20