

AL090.P0007

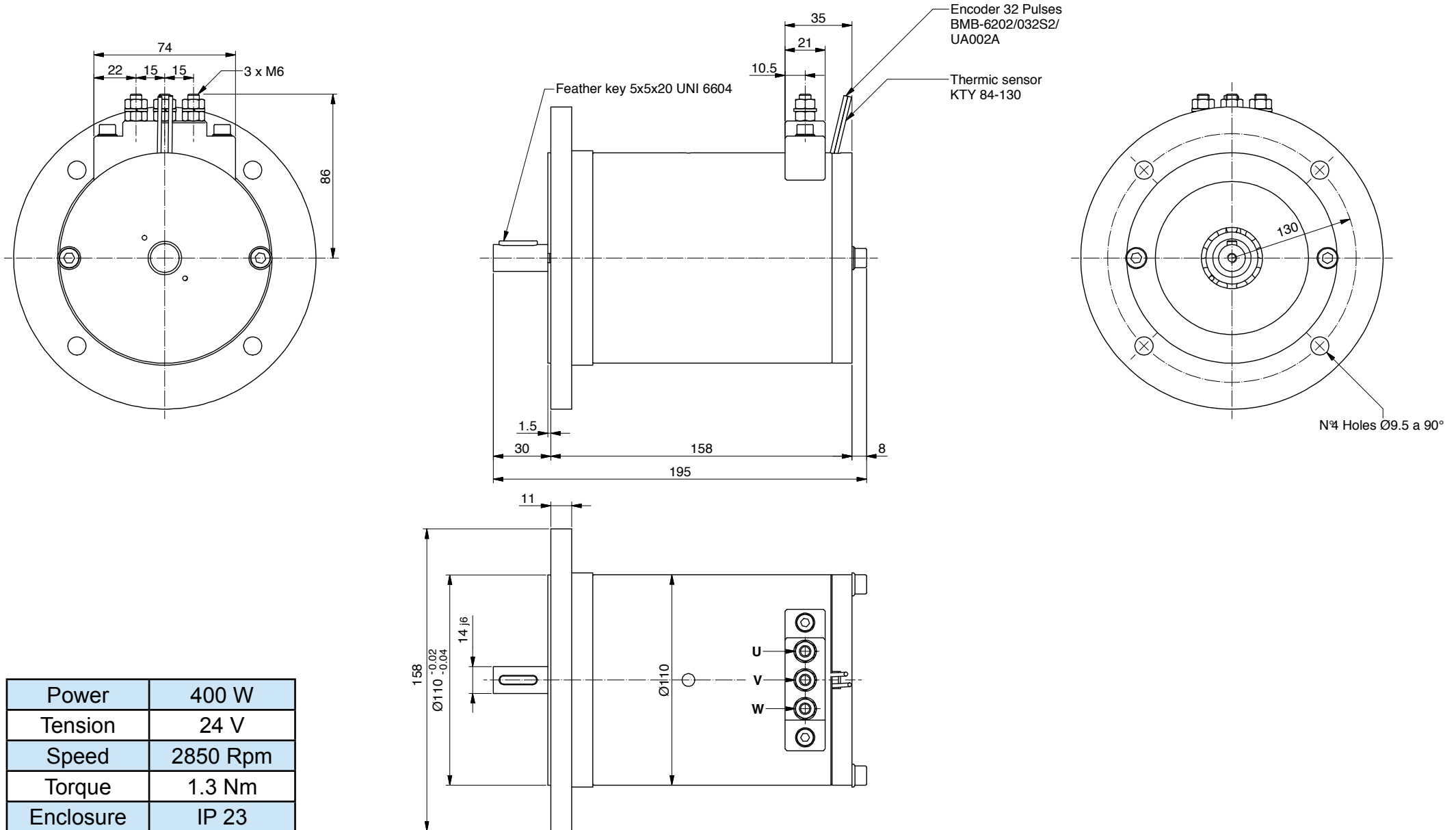

Power	400 W
Tension	24 V
Speed	2850 Rpm
Torque	1.3 Nm
Enclosure	IP 23